

(Manifestly Lorentz-Invariant) Baryon Chiral Perturbation Theory

Stefan Scherer

Institut für Kernphysik, Johannes Gutenberg-Universität Mainz

**6th Vienna Central European Seminar
on Particle Physics and Quantum Field Theory
University of Vienna, 27-29 November 2009**

- 1. Introduction**
- 2. Renormalization and power counting**
- 3. Applications I**
- 4. Applications II**
- 5. Summary**

1. Introduction

Effective field theory

... if one writes down the **most general possible Lagrangian**, including all terms consistent with assumed symmetry principles, and then calculates matrix elements with this Lagrangian **to any given order of perturbation theory**, the result will simply be the most general possible S–matrix consistent with analyticity, perturbative unitarity, cluster decomposition and the assumed symmetry principles. ... ¹

... if we include in the Lagrangian all of the infinite number of interactions allowed by symmetries, then there will be a counterterm available to cancel every ultraviolet divergence. ... ²

¹S. Weinberg, *Physica A* 96, 327 (1979)

²S. Weinberg, *The Quantum Theory of Fields, Vol. I*, 1995, Chap. 12

	Fundamental theory	Effective field theory
	QCD	ChPT
dof	quarks & gluons	Goldstone bosons (+ other hadrons)
parameters	g_3 + quark masses	(∞ # of) LECs + quark masses

Simplified analogies between multipole expansion and EFT

Multipole expansion	EFT
$ \vec{x} \gg R$	$q \ll \Lambda_\chi$
$\phi(\vec{x}) = \sum_{lm} \boxed{q_{lm}} \boxed{\frac{1}{2l+1} \frac{Y_{lm}(\theta, \phi)}{r^{l+1}}}$	$\mathcal{L}_{\text{eff}} = \sum_{lm} \boxed{c_{lm}} \boxed{\mathcal{L}_{lm}}$
multipole moment q_{lm}	LEC c_{lm}
$\frac{1}{2l+1} \frac{Y_{lm}(\theta, \phi)}{r^{l+1}}$	Structures \mathcal{L}_{lm}

- In principle, infinite number of terms.
Actual calculation: Truncation at finite order.
- Systematic improvement possible.

Perturbative calculations in effective field theory require **two main ingredients**

1. Knowledge of the **most general effective Lagrangian**

(a) Mesonic ChPT [SU(3)×SU(3)]³ (π, K, η)

$$\underbrace{2}_{\mathcal{O}(q^2)} + \underbrace{10 + 2}_{\mathcal{O}(q^4)} + \underbrace{90 + 4 + 23}_{\mathcal{O}(q^6)} + \dots$$

- q : Small quantity such as a pion mass
- Even powers
- Two-loop level

³J. Gasser and H. Leutwyler, Nucl. Phys. B250, 465 (1985);
H. W. Fearing and S. S. , Phys. Rev. D 53, 315 (1996);
J. Bijnens, G. Colangelo, G. Ecker, JHEP 02, 020 (1999);
T. Ebertshäuser, H. W. Fearing, S. S., Phys. Rev. D 65, 054033 (2002);
J. Bijnens, L. Girlanda, P. Talavera, Eur. Phys. J. C 23, 539 (2002)

(b) Baryonic ChPT $[\text{SU}(2) \times \text{SU}(2) \times \text{U}(1)]^4 (\pi, N)$

$$\underbrace{2}_{\mathcal{O}(q)} + \underbrace{7}_{\mathcal{O}(q^2)} + \underbrace{23}_{\mathcal{O}(q^3)} + \underbrace{118}_{\mathcal{O}(q^4)} + \dots$$

– Odd and even powers (spin)

– One-loop level

⁴J. Gasser, M. E. Sainio, A. Švarc, Nucl. Phys. B307, 779 (1988);
V. Bernard, N. Kaiser, U.-G. Meißner, Int. J. Mod. Phys. E 4, 193 (1995);
G. Ecker and M. Mojžiš, Phys. Lett. B 365, 312 (1996);
N. Fettes, U.-G. Meißner, M. Mojžiš, S. Steininger, Ann. Phys. (N.Y.) 283, 273 (2000)

2. Consistent **expansion scheme** for observables

- (a) Tree-level diagrams, loop diagrams \rightsquigarrow ultraviolet divergences, regularization (of infinities)
- (b) Renormalization condition
- (c) Power counting scheme for renormalized diagrams
- (d) Remove regularization

Commonly used methods

- (a) Expansion in powers of coupling constants (e. g., QED)
- (b) Loop expansion (expansion in \hbar)
- (c) **ChPT: Momentum and quark mass expansion** at fixed ratio m_{quark}/q^2 ⁵

⁵J. Gasser and H. Leutwyler, *Annals Phys.* 158, 142 (1984)

2. Renormalization and power counting

- **Most general Lagrangian**

$$\mathcal{L}_{\text{eff}} = \mathcal{L}_{\pi} + \mathcal{L}_{\pi N} = \mathcal{L}_{\pi}^{(2)} + \mathcal{L}_{\pi}^{(4)} + \dots + \mathcal{L}_{\pi N}^{(1)} + \mathcal{L}_{\pi N}^{(2)} + \dots$$

Basic Lagrangian

$$\mathcal{L}_{\pi N}^{(1)} = \bar{\Psi} \left(i\gamma_{\mu} \partial^{\mu} - \boxed{m} \right) \Psi - \frac{1}{2} \frac{\boxed{g_A}}{F} \bar{\Psi} \gamma_{\mu} \gamma_5 \tau^a \partial^{\mu} \pi^a \Psi + \dots$$

m , g_A , and F denote the chiral limit of the physical nucleon mass, the axial-vector coupling constant, and the pion-decay constant, respectively

● **Power counting:** Associate chiral order D with a diagram

– Square of the lowest-order pion mass:

$$M^2 = B(m_u + m_d) \sim \mathcal{O}(q^2)$$

– Nucleon mass in the chiral limit $m \sim \mathcal{O}(q^0)$

– Loop integration in n dimensions $\sim \mathcal{O}(q^n)$

– Vertex from $\mathcal{L}_\pi^{(2k)} \sim \mathcal{O}(q^{2k})$

– Vertex from $\mathcal{L}_{\pi N}^{(k)} \sim \mathcal{O}(q^k)$

– Nucleon propagator $\sim \mathcal{O}(q^{-1})$

– Pion propagator $\sim \mathcal{O}(q^{-2})$

• Renormalization

- Regularize (typically dimensional regularization)

$$\begin{aligned} I(M^2, \mu^2, n) &= \mu^{4-n} \int \frac{d^n k}{(2\pi)^n} \frac{i}{k^2 - M^2 + i0^+} \\ &= \frac{M^2}{16\pi^2} \left[R + \ln \left(\frac{M^2}{\mu^2} \right) \right] + O(n - 4), \end{aligned}$$

where

$$\boxed{R} = \frac{2}{n - 4} - [\ln(4\pi) + \Gamma'(1)] - 1 \rightarrow \boxed{\infty}$$

Scale μ : 't Hooft parameter (integral has the same dimension for arbitrary n)

- Adjust counterterms such that they absorb all the divergences occurring in the calculation of loop diagrams
- **Renormalization prescription:** Adjust finite pieces such that renormalized diagrams satisfy a given power counting

- Example: Contribution to nucleon mass

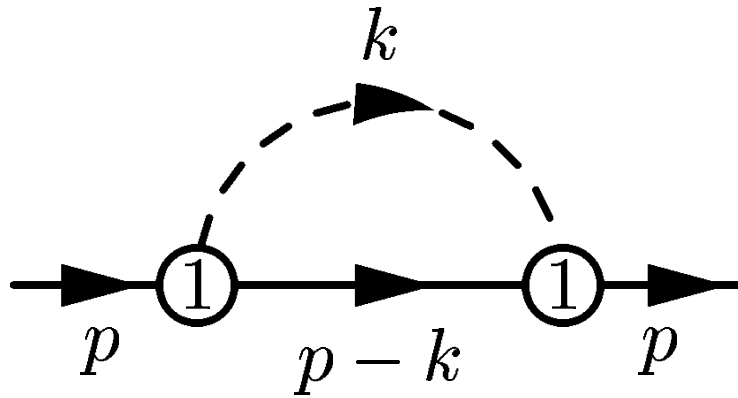

Goal: $D = n \cdot 1 - 2 \cdot 1 - 1 \cdot 1 + 2 \cdot 1 = n - 1$

$$\Sigma = -\frac{3g_{A0}^2}{4F_0^2} \left[(\not{p} + m)I_N + M^2(\not{p} + m)I_{N\pi}(-p, 0) + \dots \right]$$

Apply $\widetilde{\text{MS}}$ renormalization scheme

$$\begin{aligned} \Sigma_r &= -\frac{3g_{Ar}^2}{4F_r^2} \left[M^2(\not{p} + m) \underbrace{I_{N\pi}^r(-p, 0)}_{-\frac{1}{16\pi^2} + \dots} + \dots \right] \\ &= \mathcal{O}(q^2) \end{aligned}$$

GSS ⁶: It turns out that loops have a much more complicated low-energy structure if baryons are included. Because the nucleon mass m_N does not vanish in the chiral limit, the mass scale m (nucleon mass in the chiral limit) occurs in the effective Lagrangian $\mathcal{L}_{\pi N}^{(1)} \dots$

This complicates life a lot.

⁶J. Gasser, M. E. Sainio, A. Švarc, Nucl. Phys. B307, 779 (1988)

Solutions

- Heavy-baryon chiral perturbation theory ⁷
- Infrared regularization (IR) ⁸

Special treatment of (the Feynman parameterization of) one-loop integrals

$$\frac{1}{ab} = \int_0^1 \frac{dx}{[ax + b(1-x)]^2}$$

$$a = (k - p)^2 - m^2 + i0^+, \quad b = k^2 - M^2 + i0^+$$

$$H = \int_0^1 dx \cdots = \int_0^\infty dx \cdots - \int_1^\infty dx \cdots \equiv I + R$$

⁷E. Jenkins and A. V. Manohar, Phys. Lett. B 255, 558 (1991);
V. Bernard, N. Kaiser, J. Kambor, U.-G. Meißner, Nucl. Phys. B388, 315 (1992)

⁸T. Becher and H. Leutwyler, Eur. Phys. J. C 9, 643 (1999)

- I : power counting o.k.
- R : violates power counting; regular, i.e., can be absorbed in counterterms
- Extended on-mass-shell (EOMS) scheme ⁹

Main idea: Perform **additional subtractions** such that **renormalized** diagrams satisfy the power counting

Motivation for this approach ¹⁰

Terms violating the power counting are **analytic** in small quantities (and can thus be absorbed in a renormalization of counterterms)

⁹T. Fuchs, J. Gegelia, G. Japaridze, S. S., Phys. Rev. D 68, 056005 (2003)

¹⁰J. Gegelia and G. Japaridze, Phys. Rev. D 60, 114038 (1999)

– Example (chiral limit)

$$H(p^2, m^2; n) = \int \frac{d^n k}{(2\pi)^n} \frac{i}{[(k-p)^2 - m^2 + i0^+][k^2 + i0^+]}$$

Small quantity

$$\Delta = \frac{p^2 - m^2}{m^2} = \mathcal{O}(q)$$

We want the **renormalized** integral to be of order

$$D = n - 1 - 2 = n - 3$$

Result of integration ¹¹

$$H \sim F(n, \Delta) + \Delta^{n-3} G(n, \Delta)$$

F and G are hypergeometric functions; **analytic** in Δ for arbitrary n

¹¹ J. Gegelia, G. Japaridze, K. S. Turashvili, Theor. Math. Phys. 101, 1313 (1994)

F corresponds to **first** expanding the integrand in small quantities and **then** performing the integration

⇒ **Algorithm**: Expand integrand in small quantities and subtract those (integrated) terms whose order is **smaller** than suggested by the power counting

Here:

$$\begin{aligned} H^{\text{subtr}} &= \int \frac{d^n k}{(2\pi)^n} \frac{i}{(k^2 - 2k \cdot p + i0^+)(k^2 + i0^+)} \Big|_{p^2=m^2} \\ &= -2\bar{\lambda} + \frac{1}{16\pi^2} + O(n-4) \end{aligned}$$

where

$$\bar{\lambda} = \frac{m^{n-4}}{(4\pi)^2} \left\{ \frac{1}{n-4} - \frac{1}{2} [\ln(4\pi) + \Gamma'(1) + 1] \right\}$$

$$H^R = H - H^{\text{subtr}} = \mathcal{O}(q^{n-3})$$

- Reformulation of IR in terms of EOMS

- Formal equivalence shown at one-loop level ¹²

- Higher-order loops ¹³

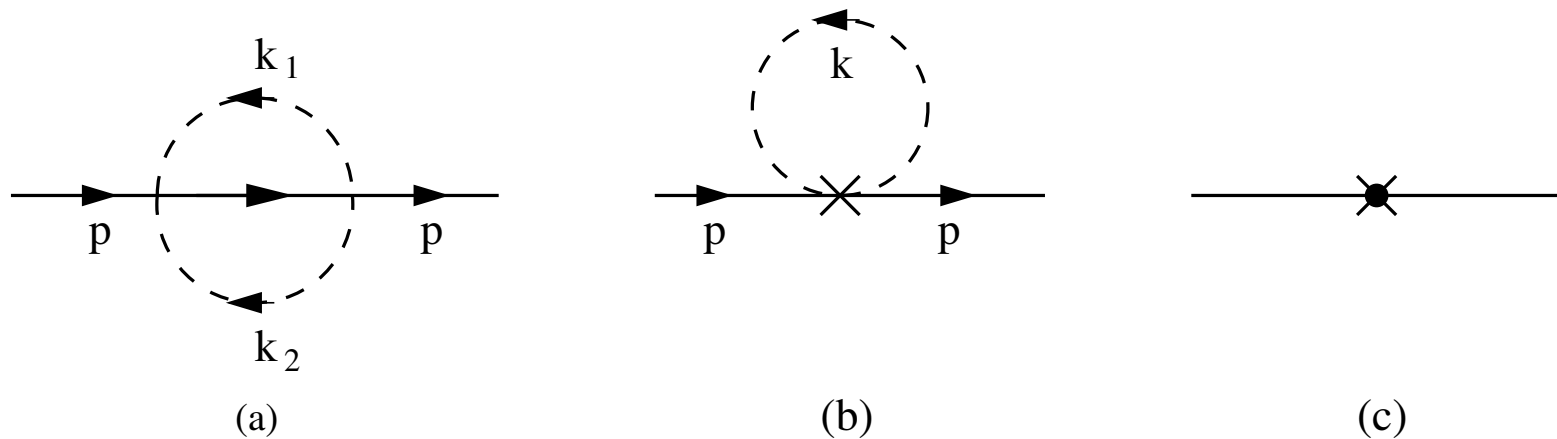

- heavy degrees of freedom ¹⁴

¹²M. R. Schindler, J. Gegelia, S. S., Phys. Lett. B 586, 258 (2004)

¹³M. R. Schindler, J. Gegelia, S. S., Nucl. Phys. B 682, 367 (2004)

¹⁴T. Fuchs, M. R. Schindler, J. Gegelia, S. S., Phys. Lett. B 575, 11 (2003)

3. Applications I

Mass of the nucleon at $\mathcal{O}(q^3)$

- GSS ($\widetilde{\text{MS}}$)¹⁵

$$m_N = m - 4c_{1r}M^2 + \frac{3g_{Ar}^2 M^2}{32\pi^2 F_r^2} m - \frac{3g_{Ar}^2 M^3}{32\pi^2 F_r^2}$$

Solution to power counting problem

Term violating the power counting is analytic in small quantities and can thus be absorbed in counterterms

Rewrite

$$c_{1r} = c_1 + \delta c_1, \quad \delta c_1 = \frac{3mg_A^2}{128\pi^2 F^2} + \dots$$

Final result for the nucleon mass at order $\mathcal{O}(q^3)$

$$m_N = m - 4c_1 M^2 - \frac{3g_A^2 M^3}{32\pi^2 F^2} + \mathcal{O}(M^4)$$

¹⁵J. Gasser, M. E. Sainio, A. Švarc, Nucl. Phys. B307, 779 (1988)

Mass of the nucleon at $\mathcal{O}(q^4)$ ¹⁶

$$m_N = m + k_1 M^2 + k_2 M^3 + k_3 M^4 \ln \left(\frac{M}{m} \right) + k_4 M^4 + \mathcal{O}(M^5)$$

$$k_3 = \frac{3}{32\pi^2 F^2} \left(8c_1 - c_2 - 4c_3 - \frac{g_A^2}{m} \right),$$

$$k_4 = \frac{3g_A^2}{32\pi^2 F^2 m} (1 + 4c_1 m) + \frac{3}{128\pi^2 F^2} c_2 - 16e_{38} - 2e_{115} - 2e_{116}.$$

$$m = [938.3 - 74.8 + 15.3 + 4.7 + 1.6 - 2.3] \text{ MeV} = 882.8 \text{ MeV}$$

$$\Delta m = 55.5 \text{ MeV}$$

Remark: $m = m_N(m_u = 0, m_d = 0, m_s)$

¹⁶T. Becher and H. Leutwyler, Eur. Phys. J. C 9, 643 (1999); T. Fuchs, J. Gellia, S. S., Eur. Phys. J. A 19, 35 (2004)

Mass of the nucleon at $\mathcal{O}(q^6)$ ¹⁷

Two-loop contributions (M. R. Schindler, PhD thesis, 2007)

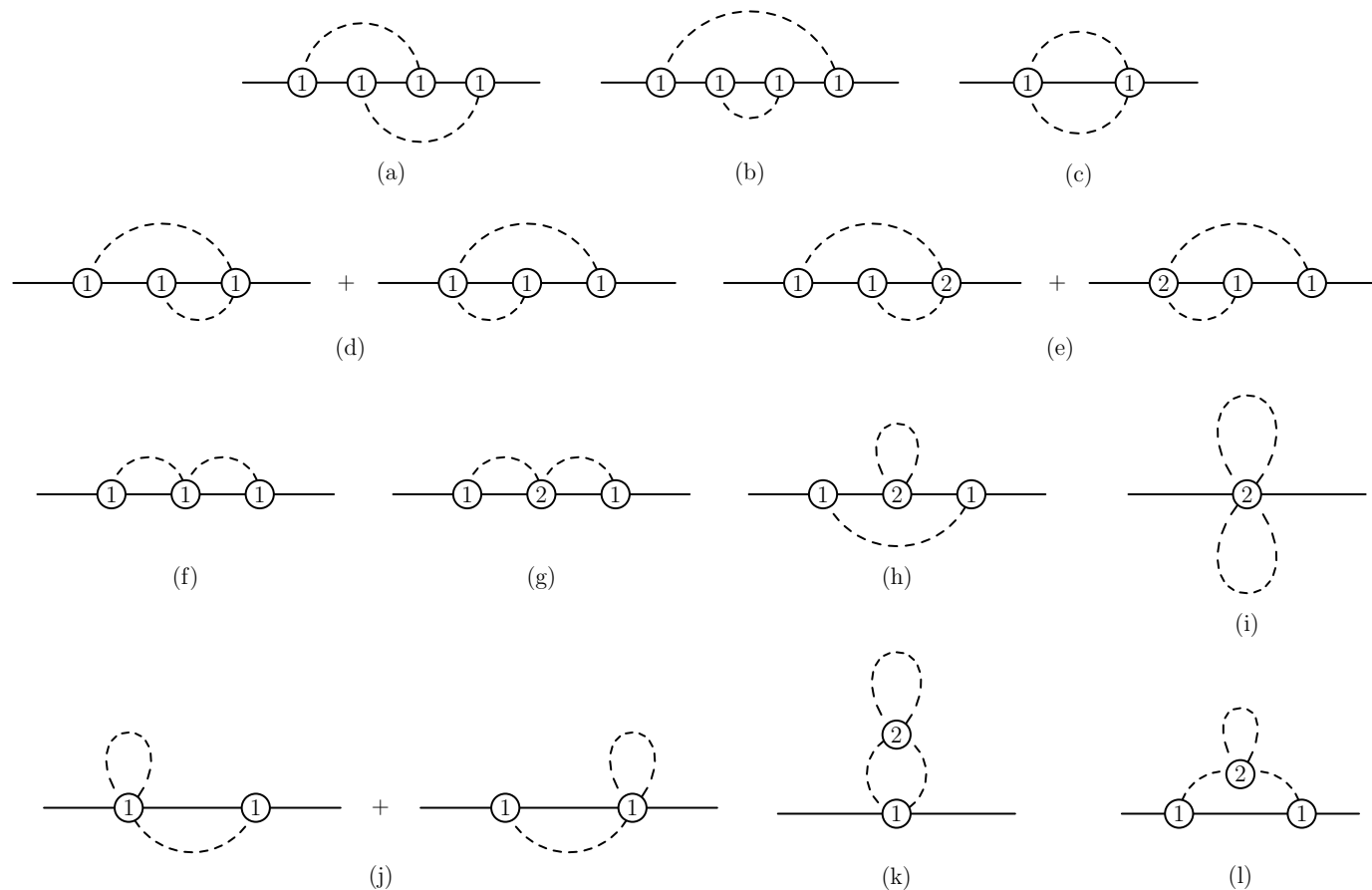

¹⁷ M. R. Schindler, D. Djukanovic, J. Gegelia, S. S., Phys. Lett. B 649, 390 (2007); Nucl. Phys. A 803, 68 (2008)

$$\begin{aligned}
m_N = & m + k_1 M^2 + k_2 M^3 + k_3 M^4 \ln \frac{M}{\mu} + k_4 M^4 \\
& + k_5 M^5 \ln \frac{M}{\mu} + k_6 M^5 + k_7 M^6 \ln^2 \frac{M}{\mu} + k_8 M^6 \ln \frac{M}{\mu} + k_9 M^6
\end{aligned}$$

} two loop

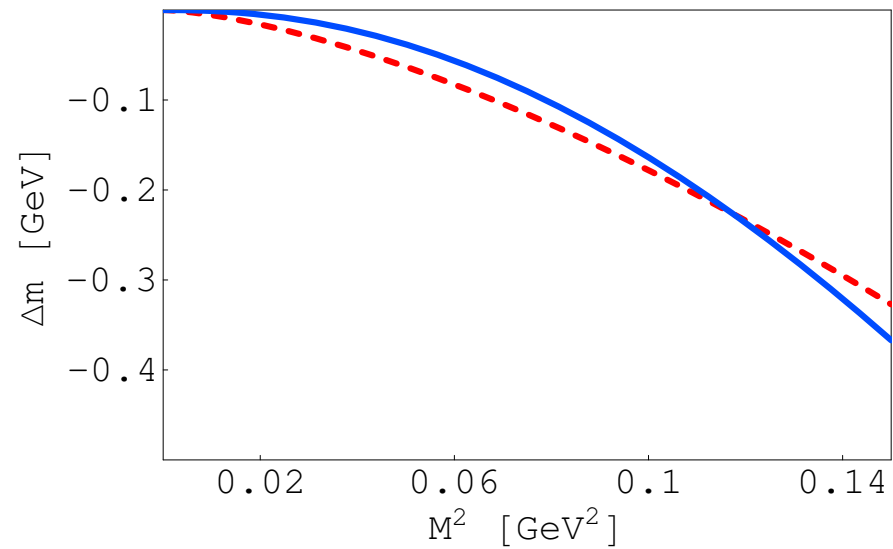

$M_0 \approx 360 \text{ MeV}$

(convergence)

At physical pion mass: $-4.8 \text{ MeV} = 31\% \text{ of } k_2 M^3$

Remarks

- Expressions of the coefficients in the chiral expansion of a physical quantity differ in various renormalization schemes
- However, the leading nonanalytic terms have to agree in all renormalization schemes
- Comparison with HBChPT ¹⁸: Agreement for k_2 , k_3 , and k_5 (consistent!)

¹⁸ J. A. McGovern and M. C. Birse, Phys. Lett. B 446, 300 (1999)

Probing the convergence of perturbative series ¹⁹

Sum up sets of an infinite number of diagrams by solving equations exactly and compare the solutions with the perturbative contributions

Example: Pion-nucleon scattering

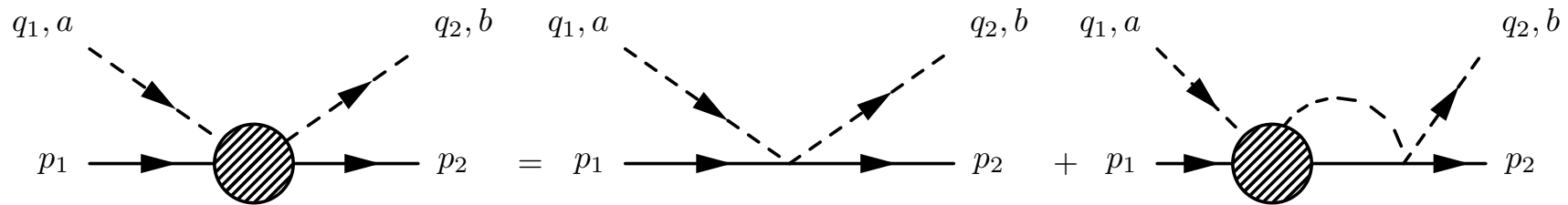

$$\Gamma^I = V^I + V^I G \Gamma^I, I = \frac{3}{2} \text{ or } \frac{1}{2},$$

$$V^{ba}(p_2, q_2; p_1, q_1) = -\frac{\epsilon^{bac} \tau^c}{4 F^2} (\not{q}_1 + \not{q}_2) - \frac{i g_A^2 \tau^b \tau^a}{4 F^2} \frac{\not{q}_2 (\not{p} - m) \not{q}_1}{p^2 - m^2}.$$

¹⁹ D. Djukanovic, J. Gegelia, S. S., Eur. Phys. J. A 29, 337 (2006)

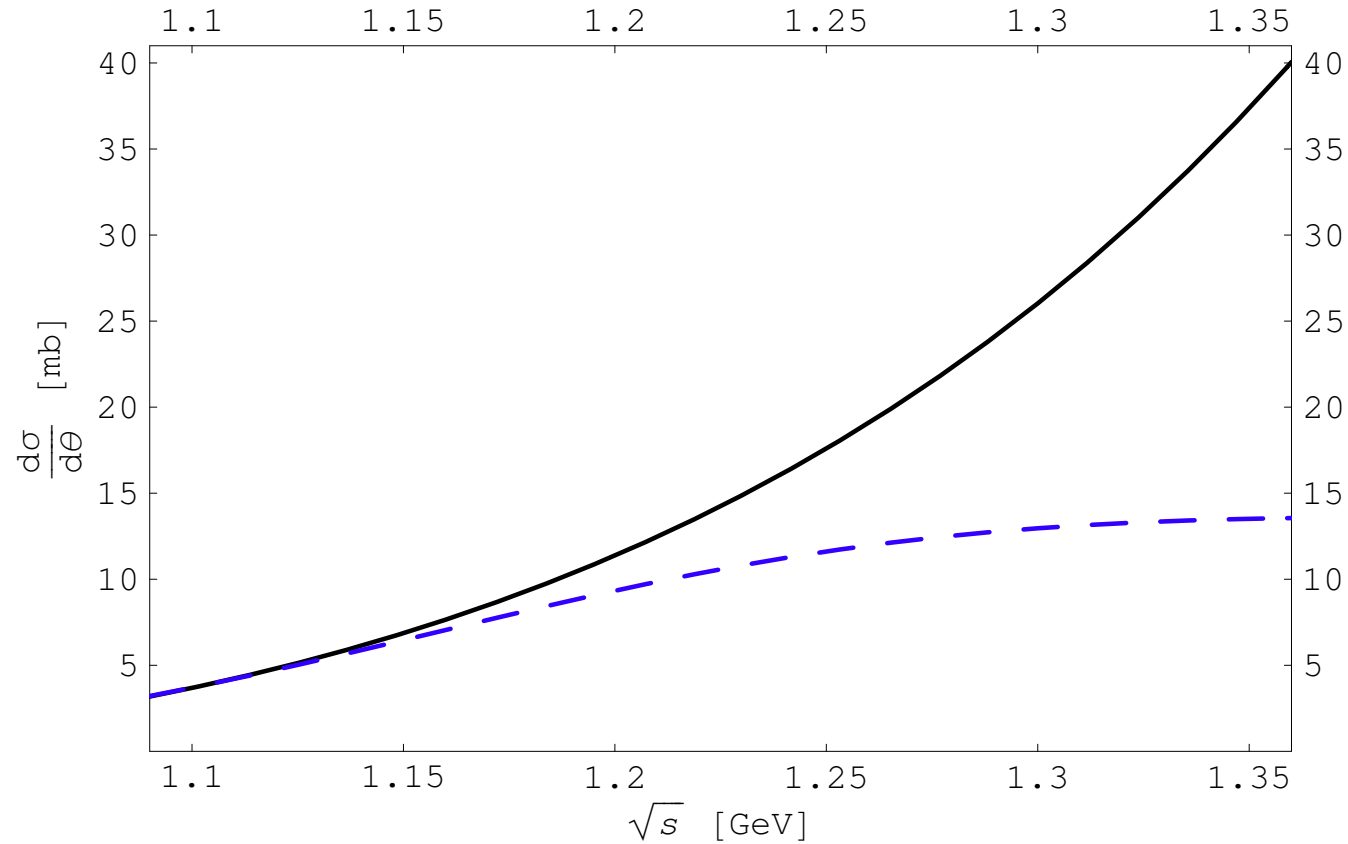

Sum of differential cross sections for $\pi^- p \rightarrow \pi^- p$ and $\pi^- p \rightarrow \pi^0 n$ in forward direction.

Solid line: non-perturbative result;

dashed line: perturbative (tree plus one-loop order) result

Example: Nucleon self-energy



$$\begin{aligned} \delta m &= -0.00233530 \text{ MeV} \\ &= (-0.00230219 - 0.00003305 - 0.00000007 + \dots) \text{ MeV}. \end{aligned}$$

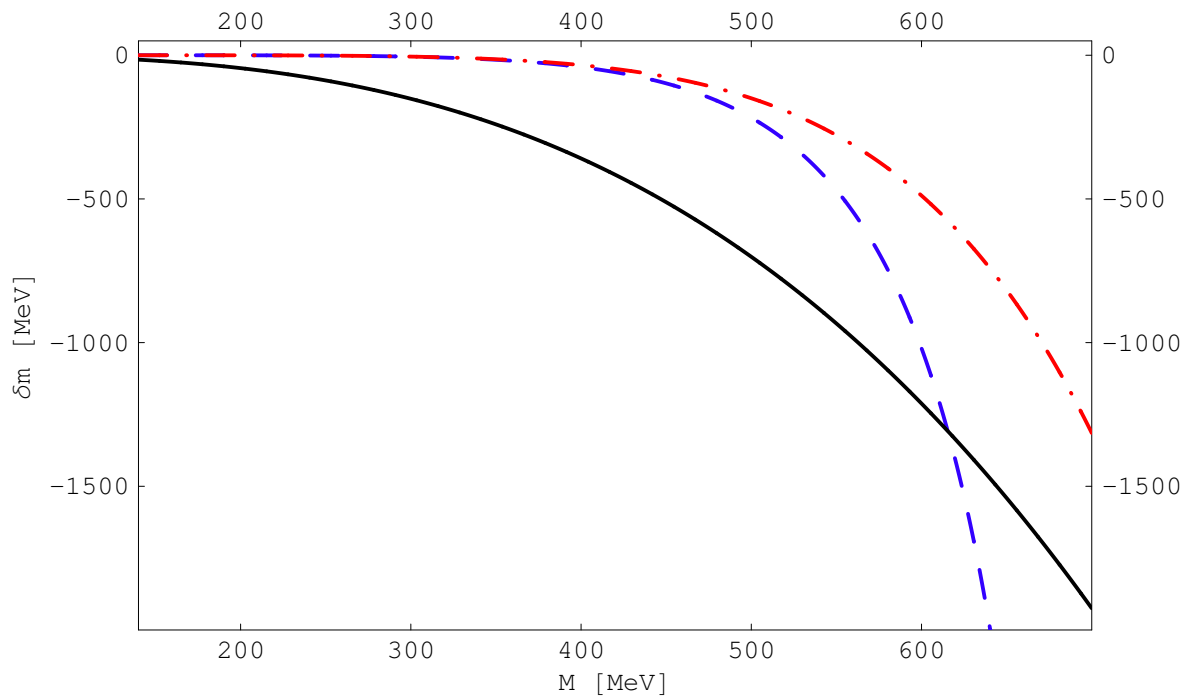

Contributions to the nucleon mass as functions of M .

Solid line: $\mathcal{O}(q^3)$;
dashed line: δm ;
dashed-dotted line: two-loop diagram.

4. Applications II

Electromagnetic form factors

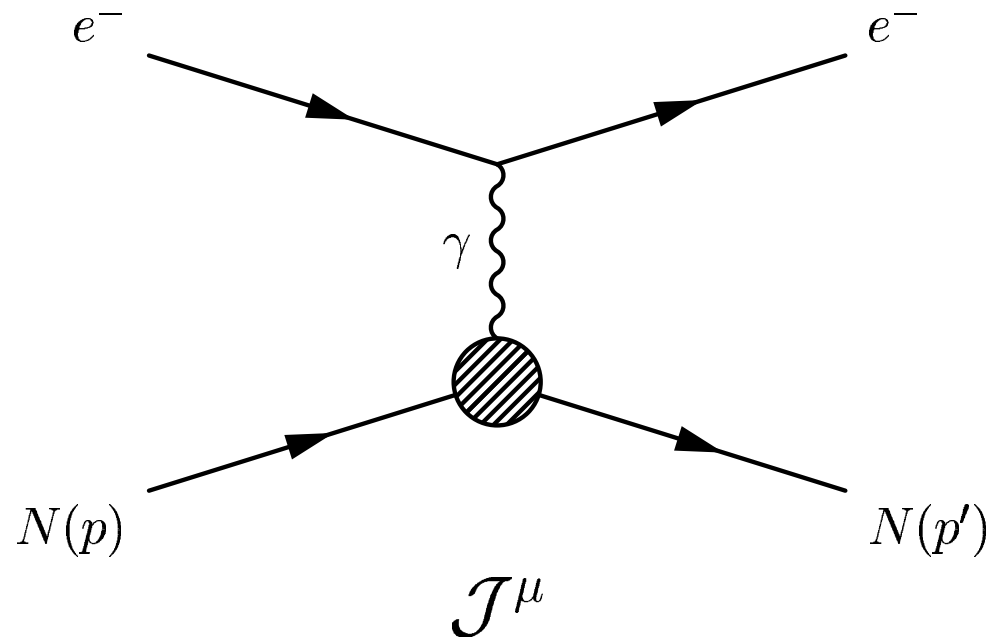

Electromagnetic current operator

$$\mathcal{J}^\mu(x) = \frac{2}{3} \bar{u}(x) \gamma^\mu u(x) - \frac{1}{3} \bar{d}(x) \gamma^\mu d(x) + \dots = \bar{q}(x) Q q(x) + \dots$$

Definition of Dirac and Pauli form factors

$$\langle N(p') | \mathcal{J}^\mu(0) | N(p) \rangle = \bar{u}(p') \left[F_1^N(Q^2) \gamma^\mu + i \frac{\sigma^{\mu\nu} q_\nu}{2m_p} F_2^N(Q^2) \right] u(p)$$

$$N = p, n, \quad q^\mu = p'^\mu - p^\mu, \quad Q^2 = -q^2$$

$$F_1^p(0) = 1, \quad F_1^n(0) = 0, \quad F_2^p(0) = 1.793, \quad F_2^n(0) = -1.913.$$

Sachs form factors

$$G_E^N(Q^2) = F_1^N(Q^2) - \frac{Q^2}{4m_N^2} F_2^N(Q^2)$$

$$G_M^N(Q^2) = F_1^N(Q^2) + F_2^N(Q^2)$$

Diagrams at $\mathcal{O}(q^4)$

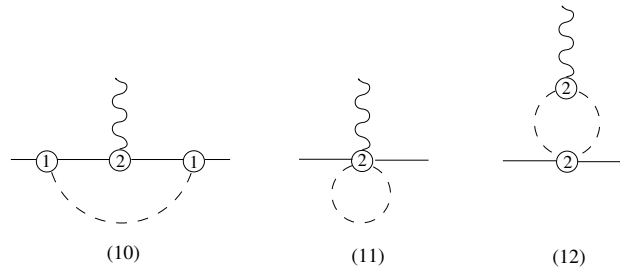
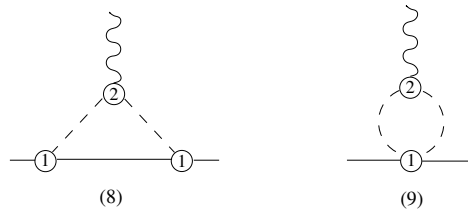
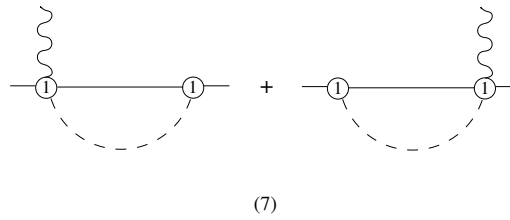
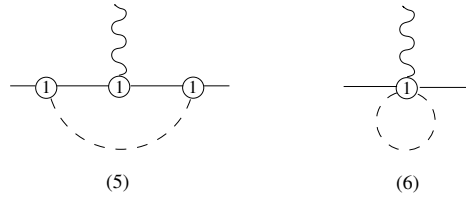
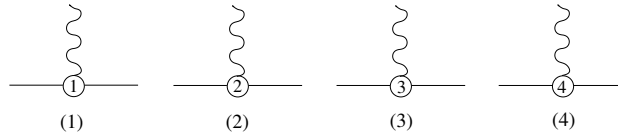

Diagrams potentially violating power counting: (5), (8), and (10).

EOMS subtractions

- Dirac form factor

$$\Delta F_1^{10} = \frac{g_A^2 m}{64\pi^2 F^2} (3c_7 - 2c_6\tau_3) t,$$

- Pauli form factor

$$\Delta F_2^5 = -\frac{g_A^2 m_N (m - 4c_1 M^2)}{32\pi^2 F^2} (3 - \tau_3),$$

$$\Delta F_2^8 = \frac{g_A^2 m_N (m - 4c_1 M^2)}{8\pi^2 F^2} \tau_3,$$

$$\Delta F_2^{10} = -\frac{g_A^2 m_N (m^2 - 8c_1 M^2 m)}{16\pi^2 F^2} (3c_7 - 2c_6\tau_3).$$

Parameters

	c_2	c_4	\tilde{c}_6	\tilde{c}_7	d_6	d_7	e_{54}	e_{74}
EOMS	2.66	2.45	1.26	-0.13	-0.57	-0.44	0.27	1.71
IR	2.66	2.45	0.47	-1.87	0.32	-0.89	0.33	1.65

The LECs c_i are given in units of GeV^{-1} , the d_i in units of GeV^{-2} , and the e_i in units of GeV^{-3} .

c_2 and c_4 from πN scattering;

\tilde{c}_6 and \tilde{c}_7 from anomalous magnetic moments;

d_6 , d_7 , e_{54} , and e_{74} from charge and magnetic radii: ²⁰

$$r_E^p = 0.848 \text{ fm},$$

$$r_M^p = 0.857 \text{ fm},$$

$$r_E^n = 0.113 \text{ fm},$$

$$r_M^n = 0.879 \text{ fm}.$$

²⁰[H. W. Hammer and U.-G. Meißner, Eur. Phys. J. A 20, 469 \(2004\)](#)

Sachs form factors ²¹ (T. Fuchs, PhD thesis, 2003)

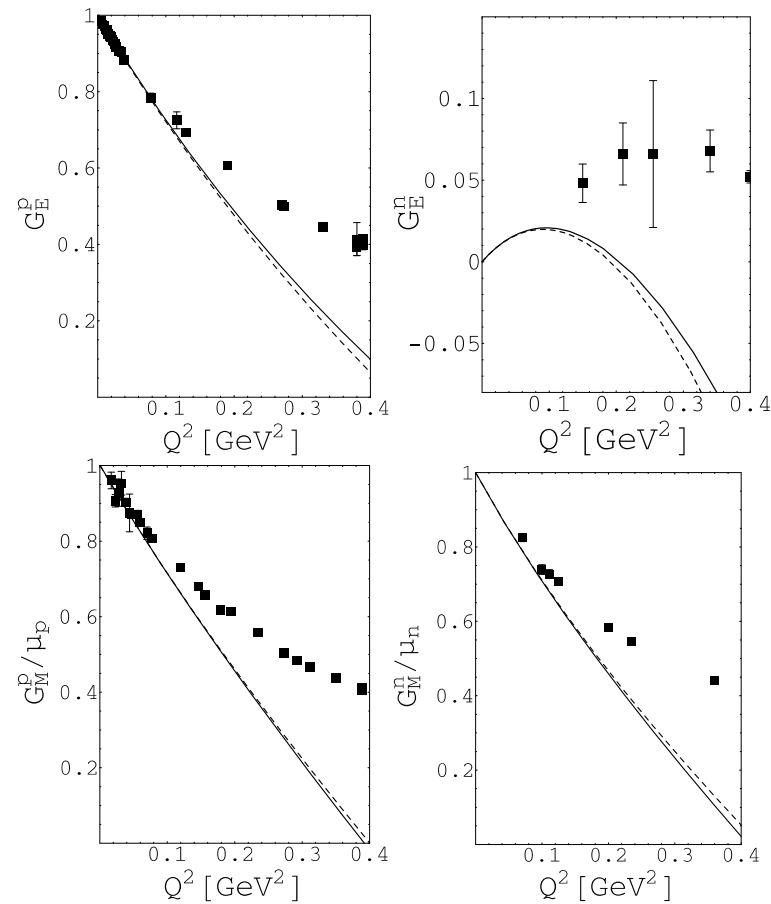

²¹ B. Kubis and U.-G. Meißner, Nucl. Phys. A679, 698 (2001); T. Fuchs, J. Gegelia, S. S., J. Phys. G 30, 1407 (2004); M. R. Schindler, J. Gegelia, S. S., Eur. Phys. J. A 26, 1 (2005); data taken from J. Friedrich and Th. Walcher, Eur. Phys. J. A 17, 607 (2003)

Vector meson dominance model → Important contributions to the electromagnetic form factors ²²

In standard ChPT: Vector meson contributions in low-energy constants

$$\frac{1}{q^2 - M_V^2} = -\frac{1}{M_V^2} \left[1 + \frac{q^2}{M_V^2} + \left(\frac{q^2}{M_V^2} \right)^2 + \mathcal{O}(q^6) \right]$$

Inclusion of vector mesons ⇒ re-summation of higher-order contributions

Reformulated IR regularization and EOMS scheme allow for consistent inclusion of vector mesons

²²**B. Kubis and U.-G. Meißner, Nucl. Phys. A679, 698 (2001)**

Inclusion of ρ , ω , and ϕ mesons ²³

Vector representation ²⁴

$$\mathcal{L}_{\pi V}^{(3)} = -f_\rho \text{Tr}(\rho^{\mu\nu} f_{\mu\nu}^+) - f_\omega \omega^{\mu\nu} f_{\mu\nu}^{(s)} - f_\phi \phi^{\mu\nu} f_{\mu\nu}^{(s)} + \dots,$$

$$\mathcal{L}_{NV}^{(0)} = \frac{1}{2} \sum_{V=\rho,\omega,\phi} g_V \bar{\Psi} \gamma^\mu V_\mu \Psi,$$

$$\mathcal{L}_{NV}^{(1)} = \frac{1}{4} \sum_{V=\rho,\omega,\phi} G_V \bar{\Psi} \sigma^{\mu\nu} V_{\mu\nu} \Psi.$$

²³M. R. Schindler, J. Gegelia, S. S., Eur. Phys. J. A 26, 1 (2005)

²⁴G. Ecker, J. Gasser, H. Leutwyler, A. Pich, E. de Rafael, Phys. Lett. B 223, 425 (1989)

Values of the vector-meson coupling constants ²⁵

f_ρ	f_ω	f_ϕ	g_ρ	g_ω	g_ϕ	G_ρ [GeV ⁻¹]	G_ω [GeV ⁻¹]	G_ϕ [GeV ⁻¹]
0.10	0.03	0.05	4.0	42.8	-20.6	13.0	0.96	-3.3

⇒ Modified couplings d_6 , d_7 , e_5 and e_{74}

	d_6	d_7	e_{54}	e_{74}
EOMS	1.21	1.30	-0.76	1.65
IR	0.98	0.24	-0.26	-0.90

Additional rules:

- Vector meson propagator $\sim \mathcal{O}(q^0)$
- Vertex from $\mathcal{L}_V^{(i)} \sim \mathcal{O}(q^i)$

²⁵H. W. Hammer and U.-G. Meißner, Eur. Phys. J. A 20, 469 (2004)

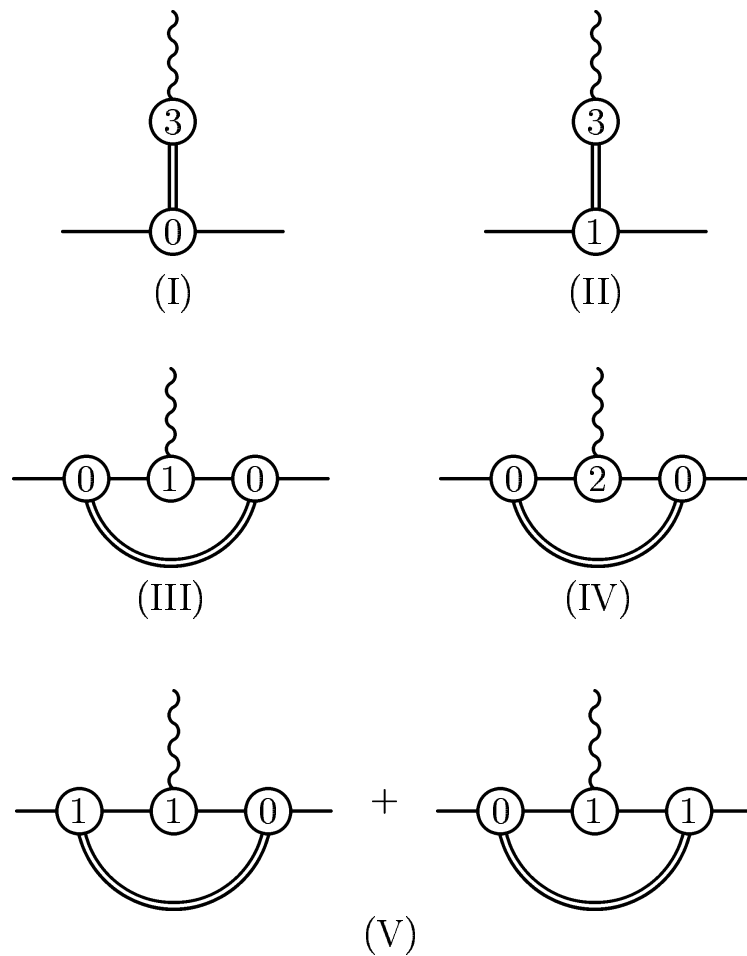

Feynman diagrams involving vector mesons contributing to the electromagnetic form factors up to and including $\mathcal{O}(q^4)$

E.m. form factors including vector mesons at $\mathcal{O}(q^4)$ ²⁶

(M. R. Schindler, thesis, 2004)

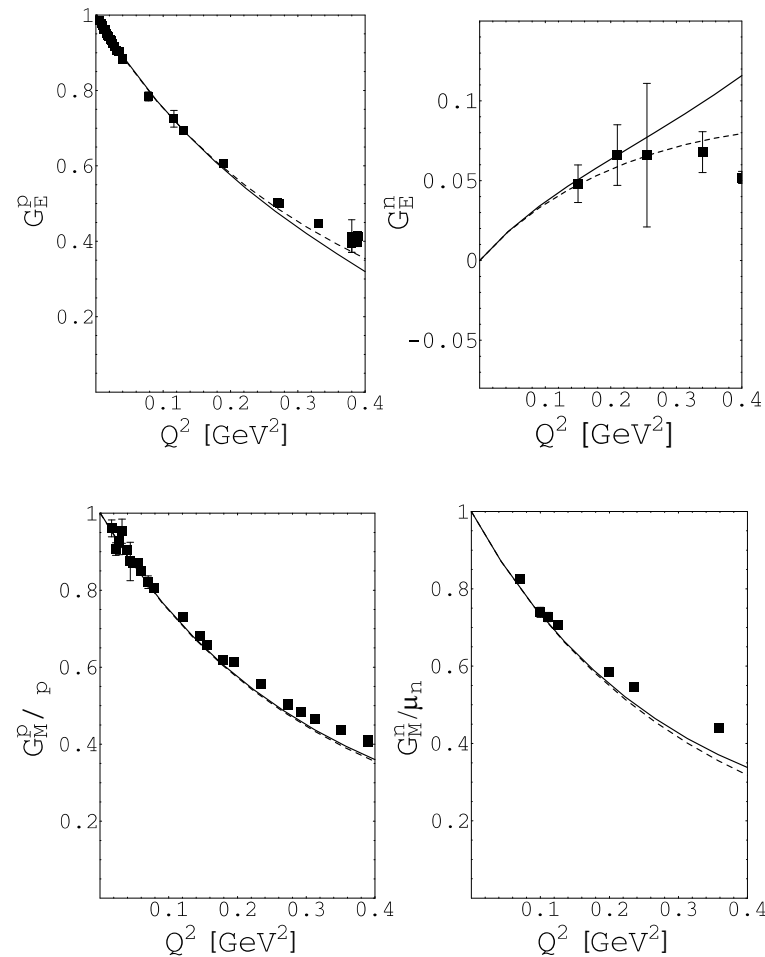

²⁶M. R. Schindler, J. Gegelia, and S. S., *Eur. Phys. J. A* 26, 1 (2005); data taken from J. Friedrich and Th. Walcher, *Eur. Phys. J. A* 17, 607 (2003)

Axial and induced pseudoscalar form factors G_A and G_P

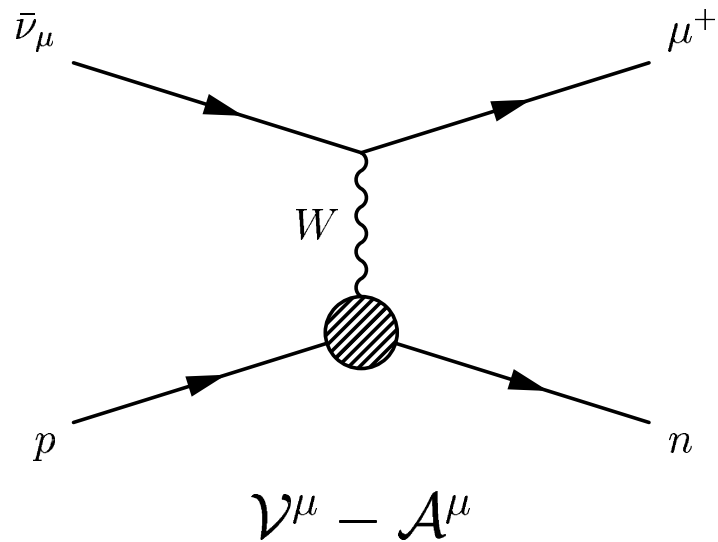

Partially
Conserved
Axial-vector
Current
 hypothesis

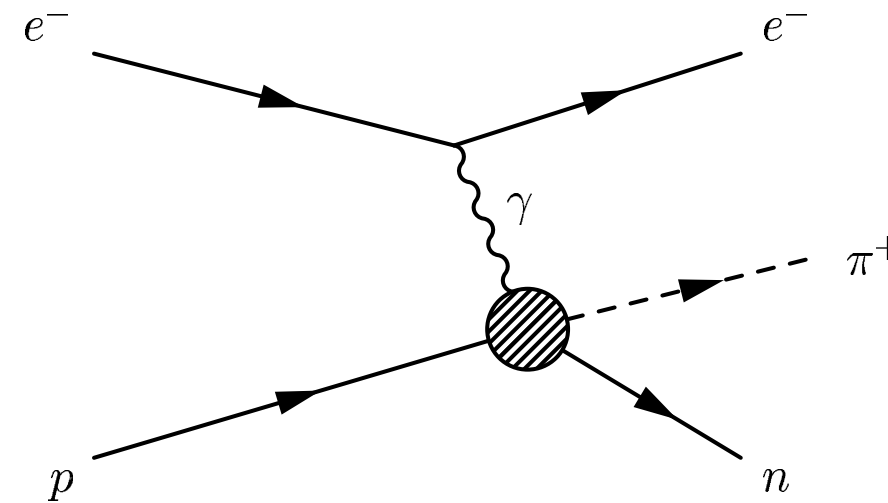

$$\langle n | \mathcal{A}^{\mu,-}(0) | p \rangle = \bar{u}(p') \left[\gamma^\mu \gamma_5 \boxed{G_A(Q^2)} + \frac{q^\mu}{2m_N} \gamma_5 \boxed{G_P(Q^2)} \right] u(p)$$

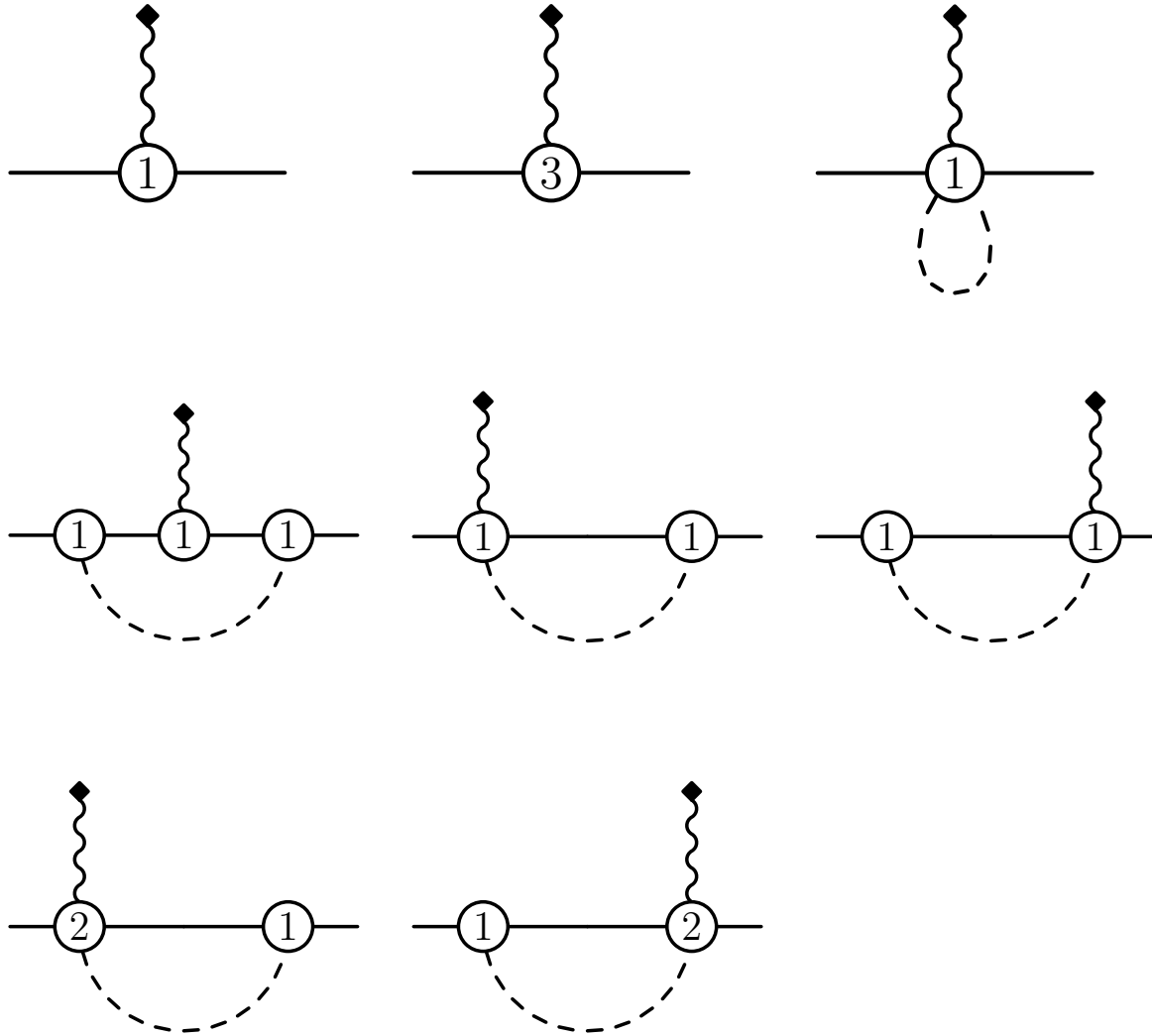

One-particle-irreducible diagrams contributing to the nucleon matrix element of the isovector axial-vector current.

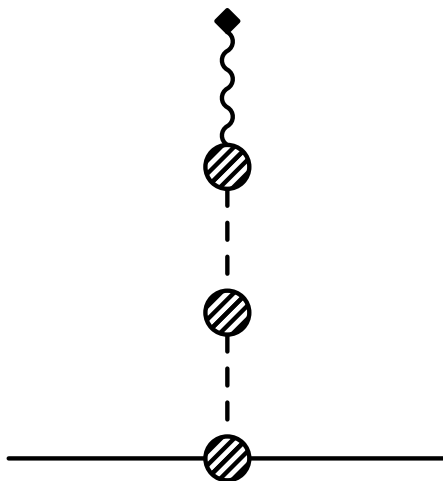

Pion pole graph of the isovector axial-vector current.

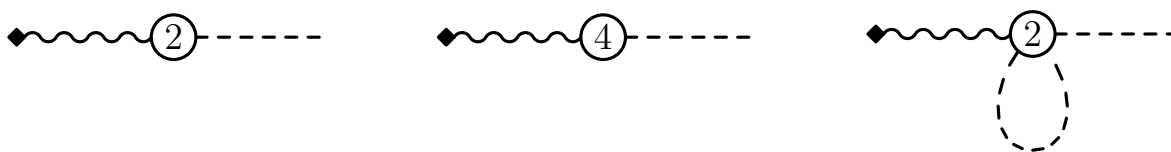

Diagrams contributing to the coupling of the isovector axial-vector current to a pion up to $\mathcal{O}(q^4)$.

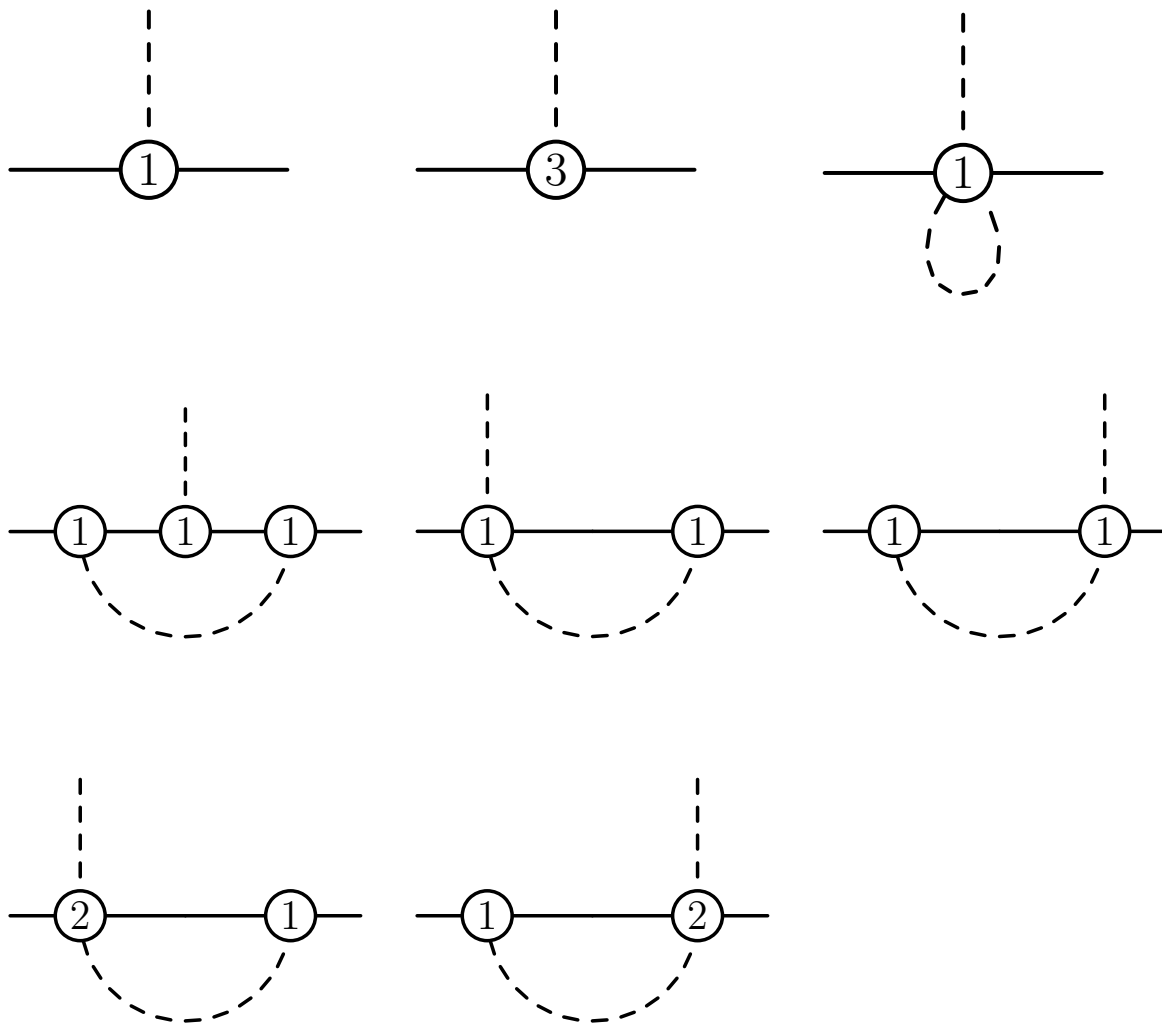

Diagrams contributing to the πN vertex up to $\mathcal{O}(q^4)$.

Result for G_A is of the form

$$G_A(Q^2) = g_A - \frac{1}{6} g_A \langle r_A^2 \rangle Q^2 + \frac{g_A^3}{4F^2} \bar{H}(Q^2).$$

$\langle r_A^2 \rangle$: axial mean-square radius (LEC)

$\bar{H}(Q^2)$: loop contributions

$$\bar{H}(0) = \bar{H}'(0) = 0.$$

Full line: result in infrared renormalization.

Again: No curvature!

Dashed line: Dipole, $M_A = 1.026$ GeV;

Dotted line: Dipole; $M_A = 0.95$ GeV;

Dashed-dotted line: Dipole $M_A = 1.20$ GeV,

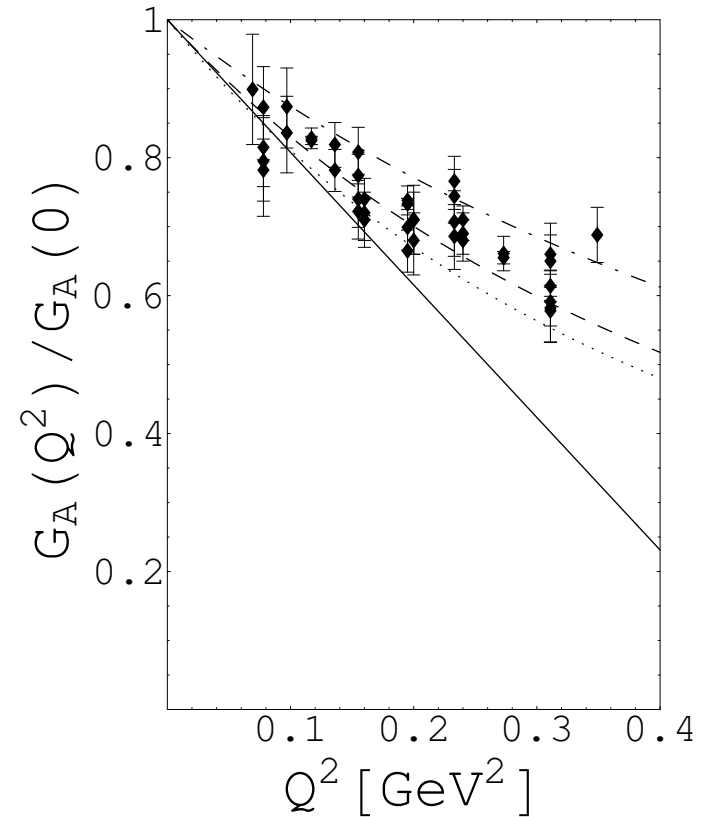

Inclusion of $a_1(1260)$ meson ²⁷

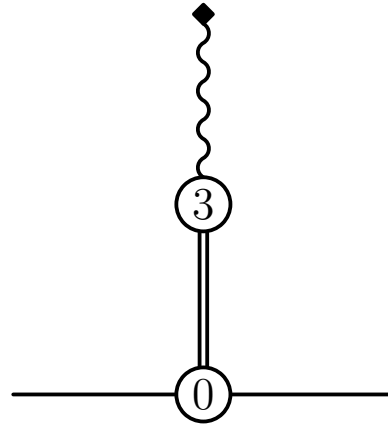
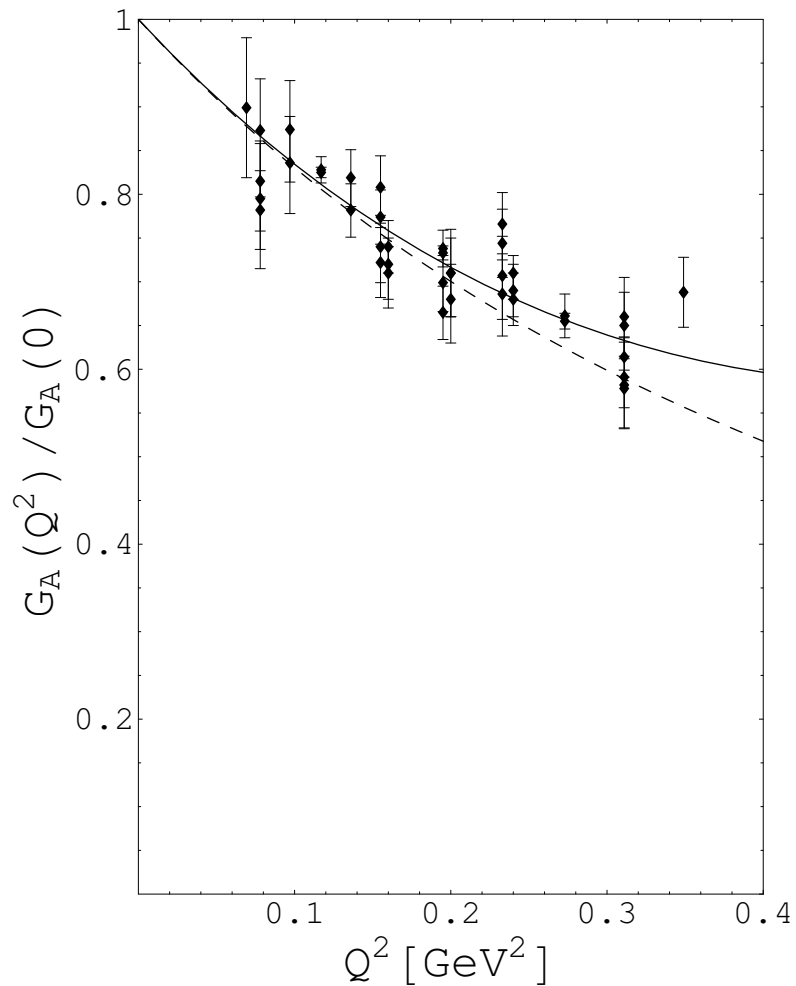

Diagram containing axial-vector meson (double line) contributing to the form factors G_A and G_P .

$$G_A^{AVM}(q^2) = -f_A g_{a_1} \frac{q^2}{q^2 - M_{a_1}^2},$$

$$f_A g_{a_1} \approx 8.70.$$

²⁷ M. R. Schindler, T. Fuchs, J. Gegelia, S. S, Phys. Rev. C 75, 025202 (2007)



G_A including a_1
 (M. R. Schindler, PhD
 thesis, 2007)

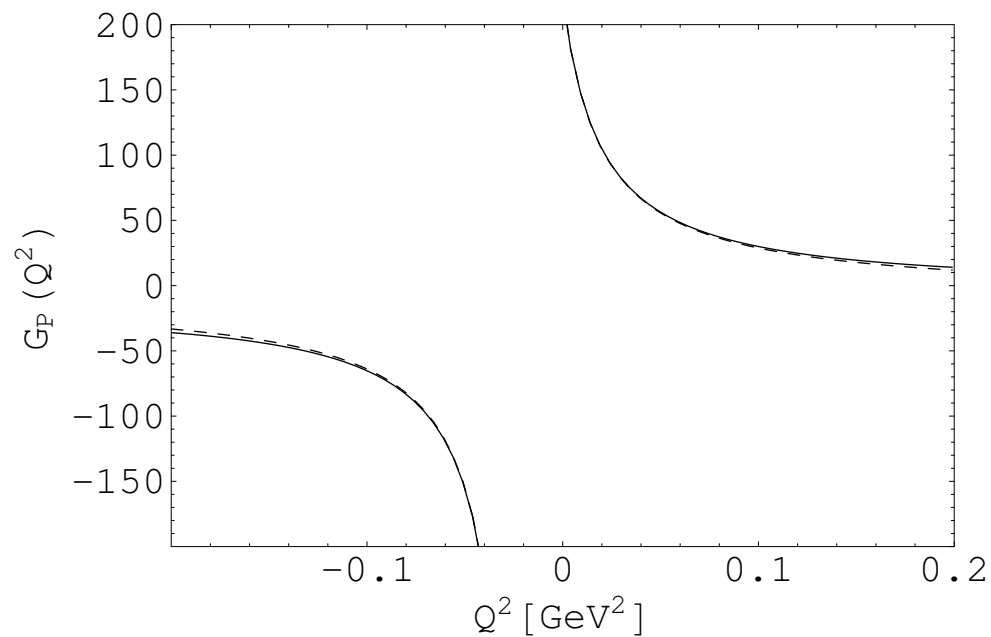

G_P at $\mathcal{O}(q^4)$
 Full line: result with axial-vector
 meson, dashed line: result wi-
 thout axial-vector meson.

Work in progress

Present: χ MAID (B. C. Lehnhart, PhD thesis 2007)

$\mathcal{O}(q^4)$: 20 tree-level diagrams + 85 loop diagrams

Example: $\gamma + p \rightarrow p + \pi^0$ at $\mathcal{O}(q^3)$ ²⁸

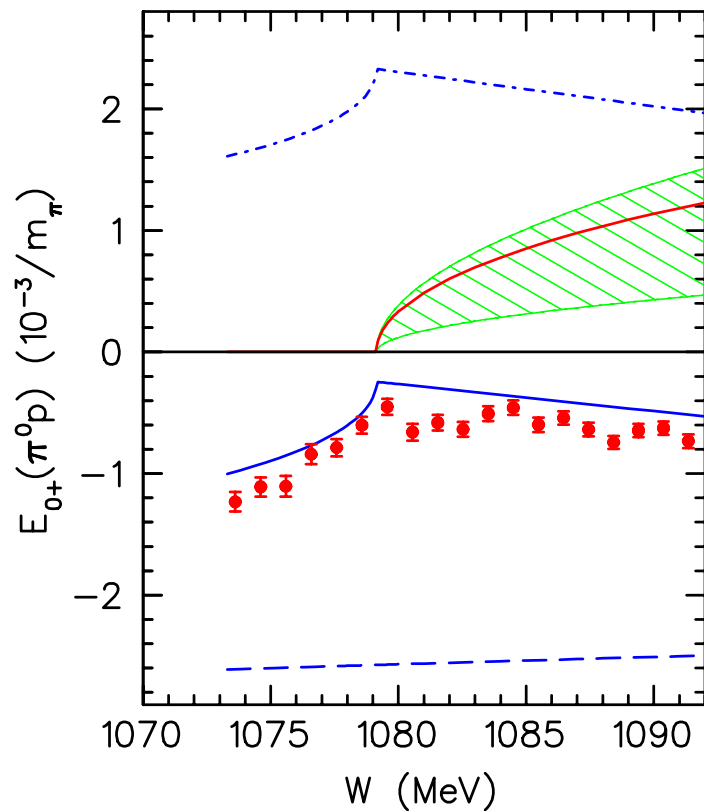

Solid blue line: real part

Solid red line: imaginary part

Cusp from taking m_n and m_{π^+} in loop

Long-dashed blue line: tree-level contribution

Dashed-dotted blue line: loop contribution

Green band: Imaginary part from ansatz $\text{Im}(E_{0+}) = \beta|\vec{q}|$

²⁸Data taken from A. Schmidt et al., Phys. Rev. Lett. 87, 232501 (2001)

(Virtual) Compton scattering off the nucleon

- Virtual Compton scattering $\gamma^* p \rightarrow \gamma p$ through $ep \rightarrow ep\gamma$

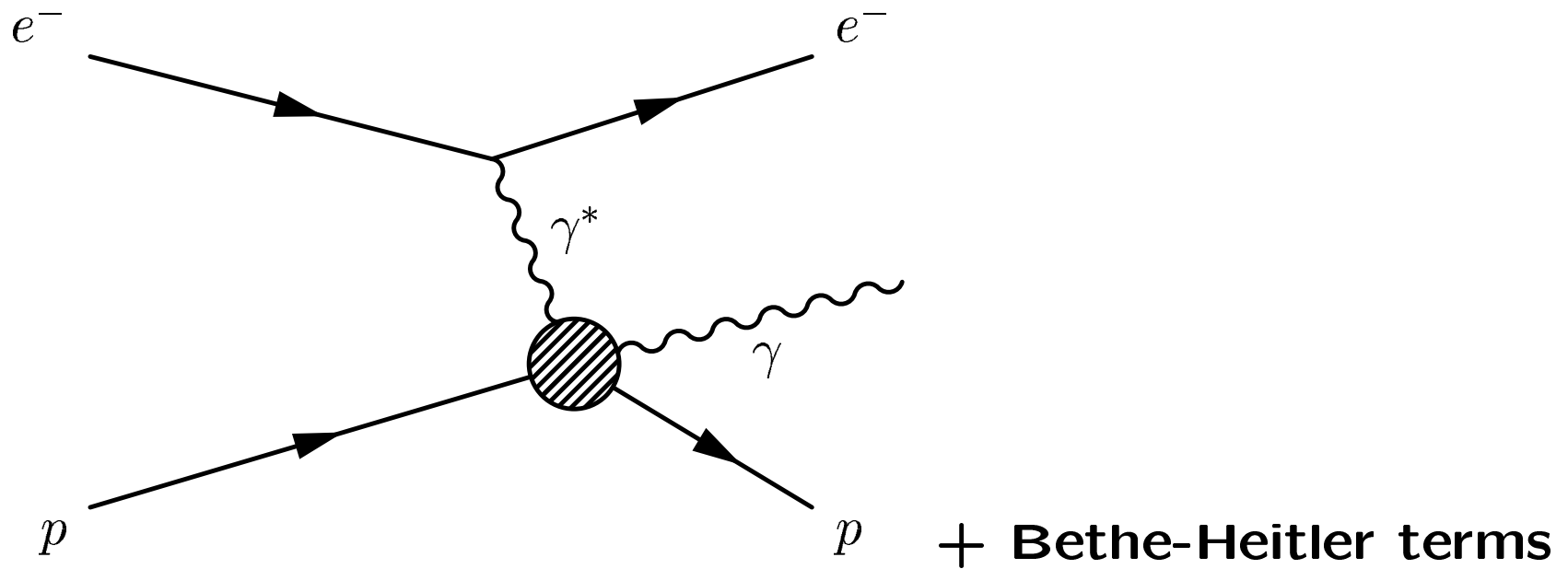

- 6 generalized polarizabilities (GPs(q^2))

- Starting point:

Program **C**ompton **S**cattering **O**bservables
(B. Pasquini, Pavia)

- Present

Development of χ **CSO** for RCS, VCS, VVCS

(Manifestly Lorentz-invariant one-loop ChPT to $\mathcal{O}(q^4)$)

- At $\mathcal{O}(q^4)$ two new parameters related to α and β of RCS
(**D. Djukanovic, PhD thesis, 2008**)

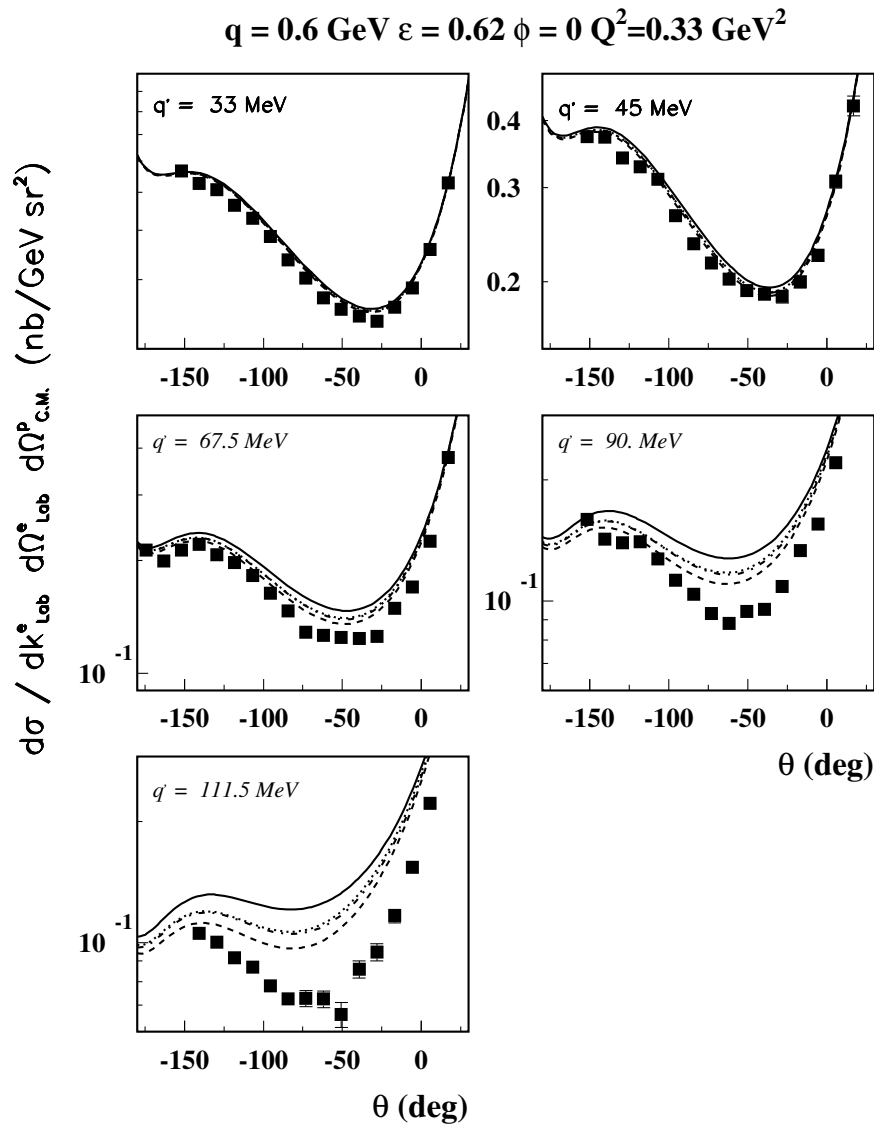

Differential cross section for $ep \rightarrow ep\gamma$ as function of the photon scattering angle in the MAMI kinematics specified in the plot. ^a

^aData taken from J. Roche et al., Phys. Rev. Lett. 85, 708, (2000)

5. Summary

- **Baryonic ChPT: Renormalization condition \leftrightarrow Consistent power counting**
- **IR and EOMS renormalization (manifestly Lorentz-invariant)**
- **Inclusion of heavy degrees of freedom/Two-loop calculation**
- **Applications: Mass of the nucleon and form factors**
- **Present and future**
 - **Electromagnetic processes: Real and virtual Compton scattering, pion photo- and electroproduction, etc.**
 - **Complex mass renormalization (see talk by J. Gegelia)**

Thanks to my collaborators

- Dalibor Djukanovic
- Dr. Thomas Fuchs
- Dr. Jambul Gegelia
- Dr. Christian Hacker
- Dr. Björn C. Lehnhart
- Dr. Matthias R. Schindler
- Natalia Wies

Thank You!

Inclusion of the $\Delta(1232)$ into ChPT ²⁹

$$\Delta(1232) : \quad I(J^P) = \frac{3}{2}(\frac{3}{2}^+)$$

Description in terms of a vector-spinor isovector-isospinor

$$\Psi_{\mu,\alpha;i,m}$$

Too many components \Rightarrow Constraints

Dirac's analysis using the Hamiltonian method:

$$L(q, \dot{q}) \quad \rightarrow \quad p_i = \frac{\partial L}{\partial \dot{q}_i} \quad \rightarrow \quad H(q, p) = p_i \dot{q}_i - L$$

But

$$\Phi_m(q, p) = 0 \quad \text{primary constraints}$$

Introduce constraints in terms of Lagrange multipliers into Hamiltonian

$$H_T = H + u_m \Phi_m$$

²⁹C. Hacker, N. Wies, J. Gegelia, S. S., Phys. Rev. C 72, 055203 (2005); N. Wies, J. Gegelia, S. S., Phys. Rev. D 73, 094012 (2006)

Consider time evolution (in terms of Poisson brackets)

$$\{H_T, \Phi_m\} = 0 \Rightarrow \text{new (secondary) constraints}$$

Iterate until all Lagrange multipliers have been solved

In a **consistent** theory

initial # of d.o.f – # of constraints = correct # of d.o.f.

⇒ Restrictions on the possible interaction terms

Example ³⁰

$$\begin{aligned} \mathcal{L}_{\pi\Delta} = & -\bar{\Psi}^\mu \left[\frac{g_1}{2} g_{\mu\nu} \gamma^\alpha \gamma_5 \partial_\alpha \phi \right. \\ & + \frac{g_2}{2} (\gamma_\mu \partial_\nu \phi + \partial_\mu \phi \gamma_\nu) \gamma_5 \\ & \left. + \frac{g_3}{2} \gamma_\mu \gamma^\alpha \gamma_5 \gamma_\nu \partial_\alpha \phi \right] \Psi^\nu \end{aligned}$$

³⁰T. R. Hemmert, B. R. Holstein, J. Kambor, J. Phys. G 24, 1831 (1998)

Analysis of constraints ³¹ ³²

$$g_2 = Ag_1,$$
$$g_3 = -\frac{1}{2}(1 + 2A + 3A^2)g_1$$

Applications so far

- Mass of the nucleon
- Pole of the Δ
- πN scattering ³³
- Magnetic moment of the Δ resonance ³⁴

³¹(A parameter of the lowest-order Lagrangian)

³²[N. Wies, J. Gegelia, S. S., Phys. Rev. D 73, 094012 \(2006\)](#)

³³[N. Wies, thesis, Mainz, 2005](#)

³⁴[C. Hacker, N. Wies, J. Gegelia, S. S., Eur. Phys. J. A 28, 5 \(2006\)](#)

Infrared regularization reformulated ³⁵

Basic idea

$$\frac{1}{ab} = \int_0^1 \frac{dx}{[ax + b(1-x)]^2}$$

$$a = (k-p)^2 - m^2 + i0^+$$

$$b = k^2 - M^2 + i0^+$$

$$H = \int_0^1 dx \dots = \int_0^\infty dx \dots - \int_1^\infty dx \dots \equiv I + R$$

In R expand the integrand in small momenta and masses and interchange summation and integration ³⁶

⇒ integrals over x of the type

$$I_i = - \int_1^\infty dx x^{n+i}, \quad i \text{ integer number}$$

³⁵M. R. Schindler, J. Gegelia, and S. Scherer, Phys. Lett. B 586, 258 (2004)

³⁶T. Becher and H. Leutwyler, Eur. Phys. J. C 9, 643 (1999)

I_i are calculated by analytic continuation from the domain of n in which they converge, i.e.

$$I_i = - \left. \frac{x^{n+i+1}}{n+i+1} \right|_1^\infty = \frac{1}{n+i+1}$$

EOMS:

- Expand integrand in small momenta and masses
- Interchange summation and integration

⇒ exactly the same expansion as for the IR regular part of the IR regularization with the only difference that instead of the integrals I_i we now have

$$J_i = \int_0^1 dx x^{n+i}$$

Calculating these integrals by analytical continuation from the domain of n in which they converge, we obtain:

$$J_i = \frac{x^{n+i+1}}{n+i+1} \Big|_0^1 = \frac{1}{n+i+1}$$

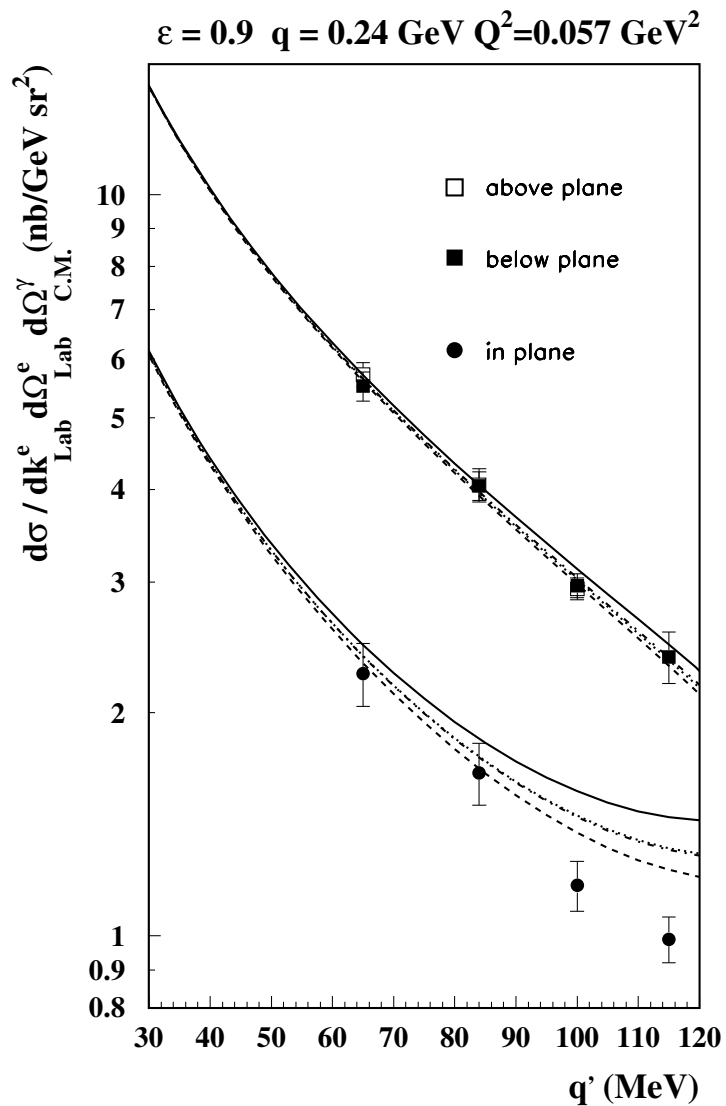

Differential cross section for $ep \rightarrow ep\gamma$ as function of the photon the outgoing photon energy in the MIT-Bates kinematics specified in the plot. ^a

^a Data taken from P. Bourgeois et al., Phys. Rev. Lett. 97, 212001 (2006)